

SCHERTLER

Schertler SA
Via Beroldingen 18
6850 Mendrisio
Switzerland
T +41 (0)91 630 07 10
F +41 (0)91 630 07 11

Scan the QR code
to open
the USER GUIDE

info@schertler.swiss
www.schertler.swiss
Facebook @schertler.sa
Instagram @schertleraudio
Youtube @Schertler SA
#shareyourschertler

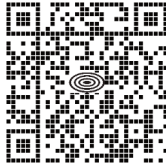

THANK YOU
FOR
CHOOSING
SCHERTLER

MAG6
QUICK GUIDE V1

QUICK START

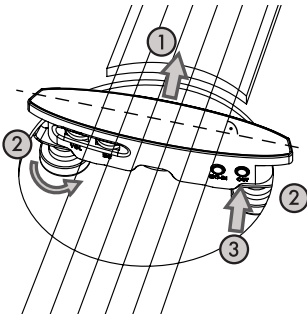

INSTALLATION

1. Position the MAGNETICO AG6 inside the soundhole and push it as close to the end of the fingerboard as possible. Make sure that the pickup is perpendicular to the strings.
2. Turn both wheels counter-clockwise to fix the pickup to the soundboard. Take care not to overtighten the clamps or you may damage the guitar's finishing.
The distance between the strings and the AG6

should be around 5mm (4mm is ideal). If the action is higher you can raise the pickup placing a thickness between the AG6 and the soundboard before tightening the wheels.

3. Connect the 1/8" jack cable to the output.

CONNECTION

Now you can plug in your mono jack and discover the pickup's amazing sound.

USER GUIDE available at www.schertler.com

DYN AG6

RECOMMENDED POSITIONING

and WARNINGS

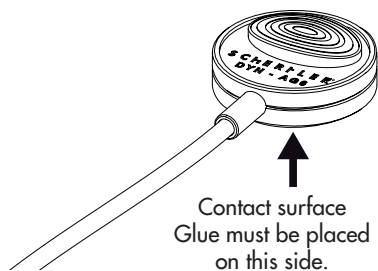
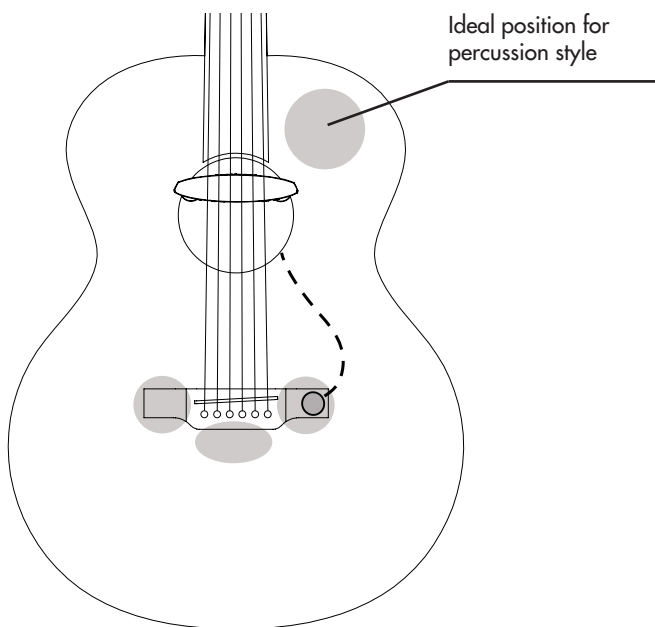

WARNING!
Fix DYN AG6 by only
applying glue on the
inside of the guitar.
Any glue used on external
surfaces can damage the
guitar's varnish.

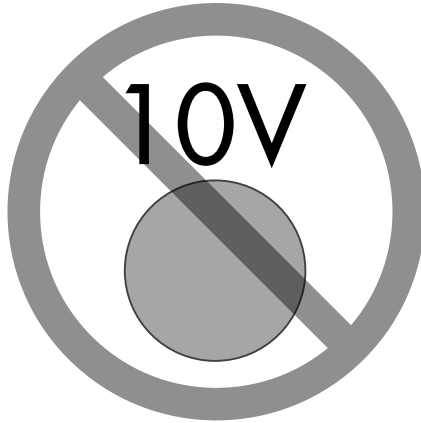

Do NOT use MAGNETICO AG6 with STAT PRE preamp nor activate the 10V on preamps, amps and mixers as it will damage the pickup.

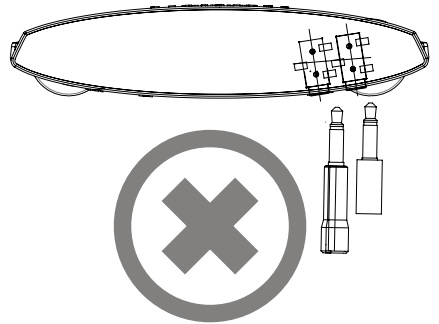
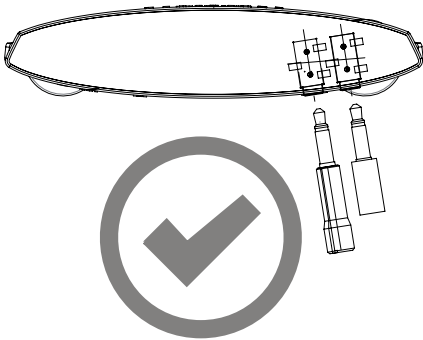

Plug and unplug the 1/8" jack connectors with caution, and only if necessary. These must be perfectly perpendicular when plugging/unplugging.

RELATED PRODUCTS

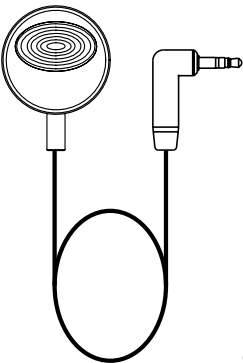

DYN AG6
contact transducer

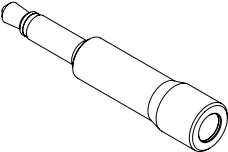

S MIC
condenser microphone

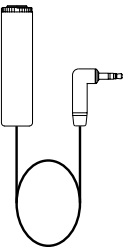

CA M EXT
External jack cable

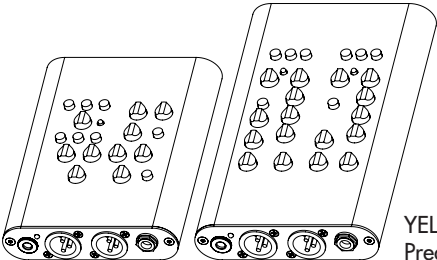

YELLOW
Preamps

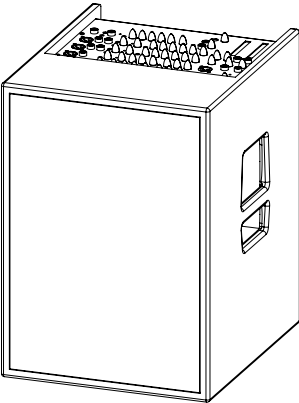

ACOUSTIC
Amps

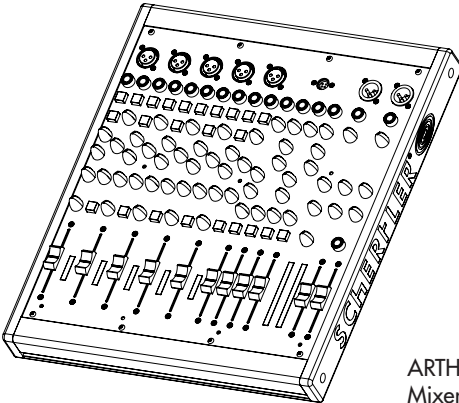

ARTHUR
Mixer